

UNITED STATES DEPARTMENT OF THE INTERIOR  
GEOLOGICAL SURVEY

DATA REPORT FOR THE 1983 U.S. GEOLOGICAL SURVEY  
EAST-CENTRAL OREGON SEISMIC REFRACTION EXPERIMENT

JOSEPH A. COTTON AND R.D. CATCHINGS  
1 1

OPEN-FILE REPORT 89-124

This report is preliminary and has not been reviewed for conformity with U.S. Geological Survey editorial standards and stratigraphic nomenclature. Any use of trade names is for descriptive purposes only and does not imply endorsement by the U.S.G.S.

<sup>1</sup>U.S.G.S. Menlo Park, California

## TABLES OF CONTENTS

	Page
Introduction.....	1
Description of Survey.....	1
Instrumentation and Data Reduction.....	3
Acknowledgements.....	4
References Cited.....	4
Appendix A: Tape Grade Codes.....	18
Appendix B: Shotpoint and Recorder Locations.....	19
Appendix C: Archive Data Tape Format.....	29

## FIGURES

1. Geologic Map of Study Area.....	2
2. Schematic Diagram of the Seismic Recorder.....	6
3. Schematic Diagram of the System Response Curve.....	7
4. Record Section of Shotpoint 1A, Shot 10.....	8
5. Record Section of Shotpoint 1B, Shot 3.....	9
6. Record Section of Shotpoint 2, Shot 7.....	10
7. Record Section of Shotpoint 3, Shot 4.....	11
8. Record Section of Shotpoint 4, Shot 6.....	12
9. Record Section of Shotpoint 5A, Shot 2.....	13
10. Record Section of Shotpoint 5B, Shot 8.....	14
11. Record Section of Shotpoint 6A, Shot 9.....	15
12. Record Section of Shotpoint 6B, Shot 1.....	16

## TABLES

1. Master Shot List (Shot Location and Time).....	17
---	----

## INTRODUCTION

In October of 1983, the U.S. Geological Survey conducted a long-range seismic refraction survey across east-central Oregon. A single east-west profile as recorded from the eastern High Cascades across Newberry Crater to the eastern High Lava Plains. The purpose of the investigation was to determine the sub-volcanic crustal and upper mantle velocity structure of Newberry Volcano and the surrounding region. East-central Oregon is of great geologic interest, as it includes the arc-to-back-arc transition zone between two major geologic provinces; the actively extending Basin and Range and the volcanic Cascade mountains. Furthermore, this area marks the southernmost terminus of the Columbia Plateau, the third largest continental flood basalt province on Earth, and an area in which similar data has been acquired (Cotton and Catchings, 1988).

Included in this report are record sections (Figures 4- 12), lists of shot times, recorder and shotpoint locations (Table 1), data files and a tape grade scale (Appendix A & Appendix B). The data from this experiment have been archived at the National Oceanic and Atmospheric Administration (N.O.A.A.). Tapes may be obtained at the

National Geophysical Data Center  
National Oceanic and Atmospheric Administration  
325 Broadway  
Boulder, CO., 80303

Appendix C contains a description of the tape formats. An interpretation of the data has been published in a report by Catchings and Mooney (1988).

## DESCRIPTION OF SURVEY

The 1983 east-central Oregon profile consisted of a 180-km-long transect which originated in the High Cascades roughly 30 km west of Newberry Volcano and trended east across the High Lava Plains (Figure 1). The transect was recorded in two deployments: the Newberry deployment (the western half of the profile) which extended from Wickiup Dam, Oregon to Riley, Oregon and the Brothers Fault Zone deployment (the eastern half of the profile) which extended from the Riley, Oregon to Harney, Oregon. Each deployment consisted of 120 seismic cassette recorders (SCR), but the field parameters varied significantly for each deployment. Five separate shotpoints, spaced approximately 15 km apart (1, 2, 3, 4, 5, and the offset shotpoint #6), were situated along the 60-km long-Newberry deployment. SCR's were spaced at approximately 0.5 km intervals. These parameters were used in order to provide higher resolution of the subsurface beneath the Newberry Volcano. Three shotpoints, spaced approximately 60 km apart (shotpoints 1, 5, and 6), were recorded along the Brothers Fault Zone deployment with SCR's spaced at approximately 1.3 km intervals. These parameters for the Brothers Fault Zone deployment were utilized in order to provide deeper, large-scale crustal data.

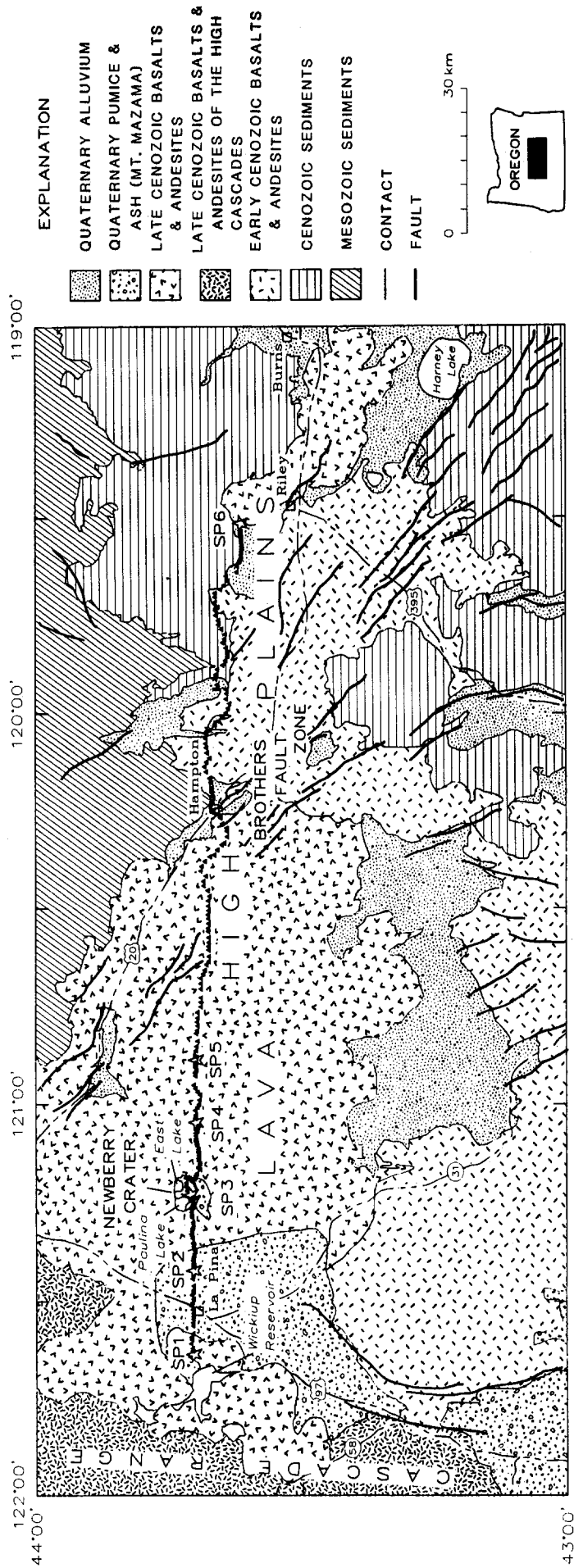

Figure 1: Geologic/ Location map of the 1983 east-central Oregon seismic refraction transect.

Sources were generated from a total of ten (See Table 1) 900-to 2000-kg explosions located at six different shotpoints . Explosions were detonated in 20-cm diameter drillholes ranging in depth from 40 to 60 meters. The drillholes were loaded with ammonium nitrate explosives, boosters, and detonation cord and tamped with approximately 20 meters of gravel. Explosions were detonated with an automated shooting system described by Healy et al. (1982). A signal from a reference chronometer triggered the shooting system by igniting an electrical blasting cap. The cap break, and two time-code signals, WWVB and IRIG E, were recorded on paper strip charts from which origin times were subsequently determined. Assuming explosions and cap break were instantaneous, shot times were maintained to within an accuracy of  $\pm 2$  milliseconds.

Recorder locations, shotpoint locations, and elevations, were determined from USGS orthophotos (1:24000) and topographic maps (1:24000 and 1:62500) and are estimated to be accurate to within 20 meters. Locations were checked using Brunton compass readings, precision odometers, and vehicle odometers.

Information pertaining to shot location and reference time can be found in Table 1 .

## INSTRUMENTATION AND DATA REDUCTION

### Seismic Recorders

The USGS seismic cassette recorders consist of an analog cassette tape recorder and a vertical-component, 2-Hz geophone (Figure 2). The seismic signal received by the geophone is diverted through three parallel amplifiers, each with an adjustable gain setting (0 to 104 db). The three amplified seismic signals, a constant reference frequency (FSK), and an internally generated time code (IRIG E) are recorded as a multiplexed signal in analog form on a 30-minute cassette tape. Each recorder contains a time code generator and memory circuitry which allows pre-programming of ten separate time windows.

Prior to the recording of seismic data, a micro-processor within each recorder performs a geophone release test, an amplification step test, and then records a calibration sequence consisting of 10-Hz sine waves with amplitudes of 1, 10 , 100, and 1000 microvolts. The system measures velocity with a frequency response that peaks at 6 Hz and sharply rolls off beyond 20 Hz, avoiding 60 Hz contamination (Figure 3). The tests are recorded on cassette tapes and can be referenced during processing to evaluate the performance quality of the seismic recording system.

### Data Reduction

Information pertaining to the performance of each SCR was recorded on field data sheets (Appendix B). Chronometer corrections were determined for each record assuming a linear drift rate. Twenty seconds of seismic data were then converted from analog to digital format at a sampling rate of 2 milliseconds. Digitization began at :

$$T = \text{SHOT TIME} - 2 \text{ SECONDS} + X / 6.0 \text{ km/s}$$

where X is the distance in kilometers from the shotpoint to the recorder in question. Following the digitization process, each trace was evaluated and assigned a tape grade (Appendix A ).

Seismic record sections (Figures 4-12) are plotted with all traces normalized to a common amplitude and with a standard reduction velocity of 6.0 km/s. Sections are presented using variable area shading at 65 % pulse width.

### ACKNOWLEDGEMENTS

We wish to express our appreciation to U. S. Geological Survey's Geothermal Program for providing funding for the acquisition of these data. The efforts of Walter Mooney and the U.S. Geological Survey's seismic refraction field crew, Bob Colburn, Coyn Criley, Ed Criley, Phil Dawson, Wendy Grant, Ron Kaderabik, Will Kohler, Nan Scott-McGregor, Pat Meador, Janice Murphy, Thomas Reed, John Van Shack, Moses Smith, Vicki Sutton, and Al Walter are greatly appreciated.

### REFERENCES CITED

- Barry, K.M., Cavers, D.A., and Kneale, C.W., 1975, Recommended standards for digital tape formats, *Geophysics* 40, 344-352 p.
- Catchings, R.D., and Mooney, W.D., 1988, Crustal structure of east central Oregon: Relation between Newberry volcano and regional crustal structure, *Journ. Geophys. Res.*, v.93, 10,081-10,094 p.
- Cotton, J.A., and Catchings, R.D., 1988, Data report for the 1984 U.S. Geological Survey Central Columbia Plateau Seismic Refraction Experiment, Washington-Oregon:, U.S. Geological Survey Open File Report 88-226, 56 p.

Dawson, P.B., Stauber, D.A., 1986, Data report for a three-dimensional high resolution P-velocity structural investigation of Newberry volcano, Oregon, using seismic tomography:, U.S. Geological Survey Open File Report 86-352, 77 p. 5

Healy, J.H., Mooney, W.D., Blank, H.R., Gettings, M.E., Kohler, W.M., Lamson, R.J., and Leone, L.E., 1982, Saudi Arabian seismic deep-refraction profile: Final project report:, U.S. Geological Survey Open File Report USGS-of-02-37, 429 p.

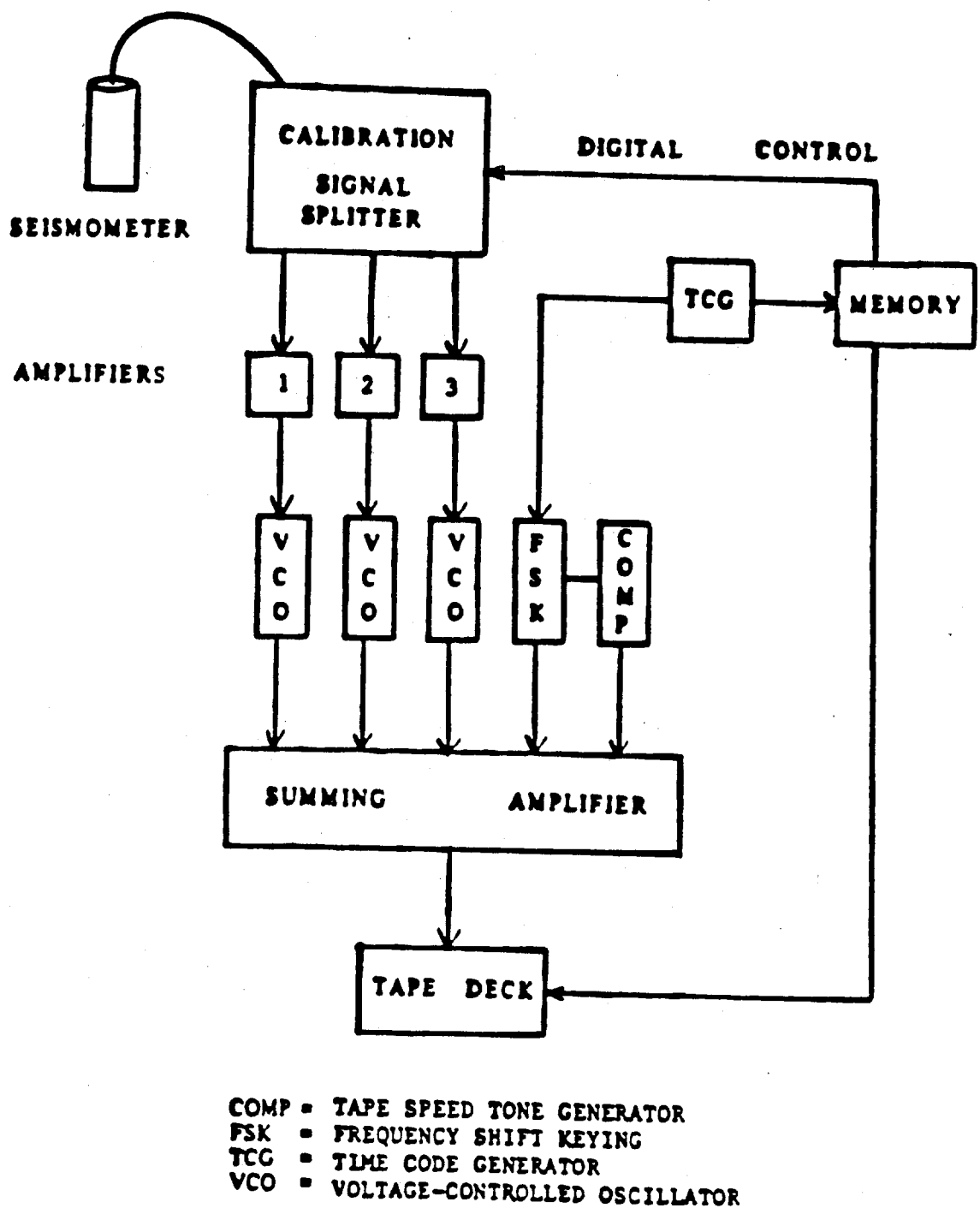

Figure 2. Schematic diagram of USGS seismic cassette recorders (from Healy et al., 1982, Figure 13).



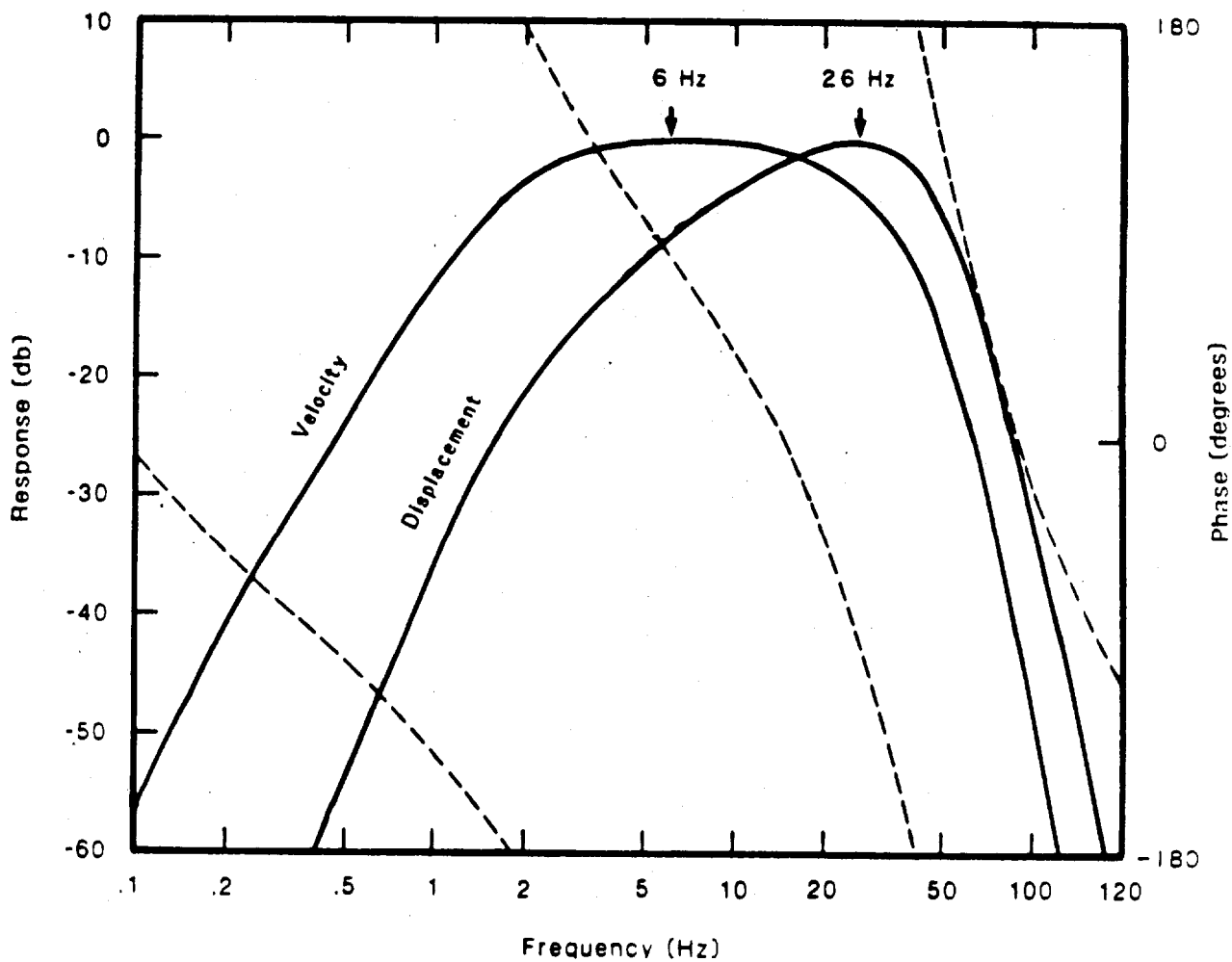
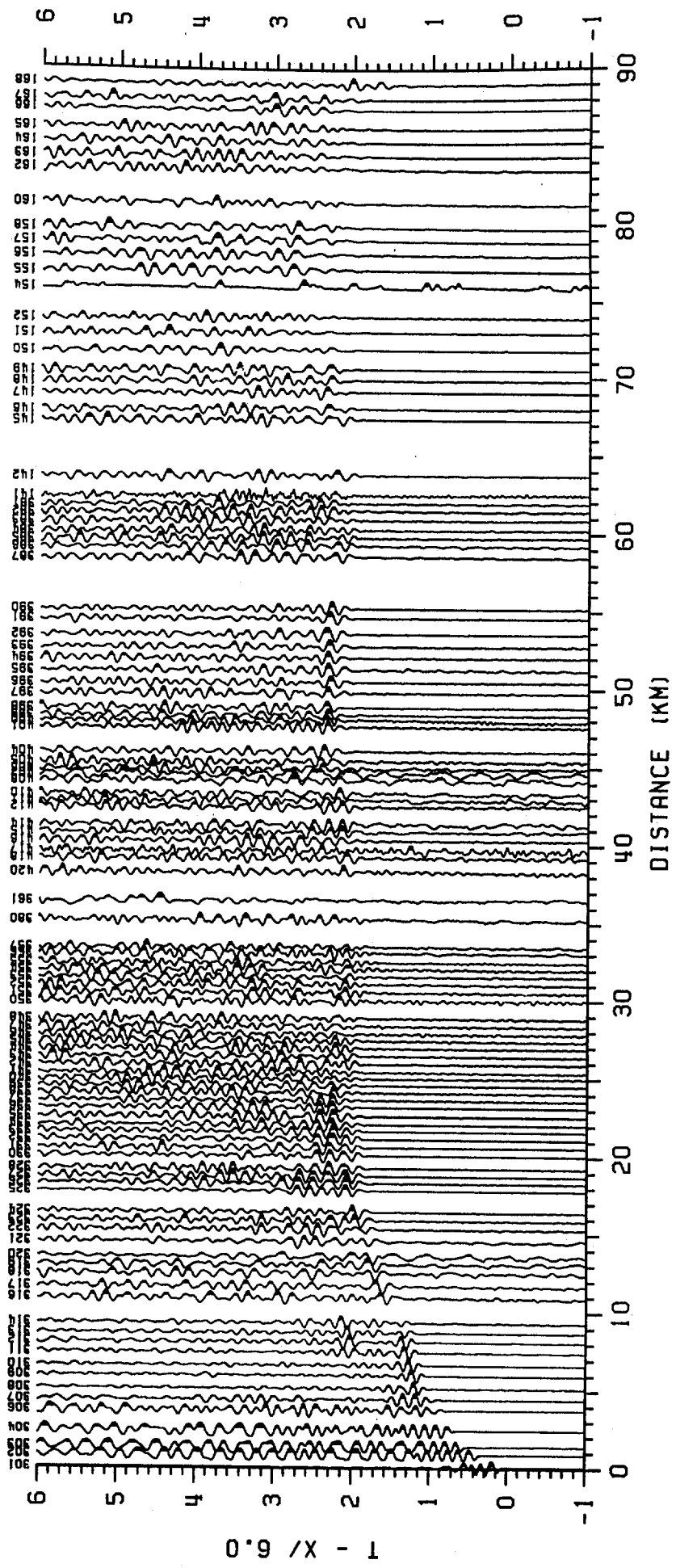
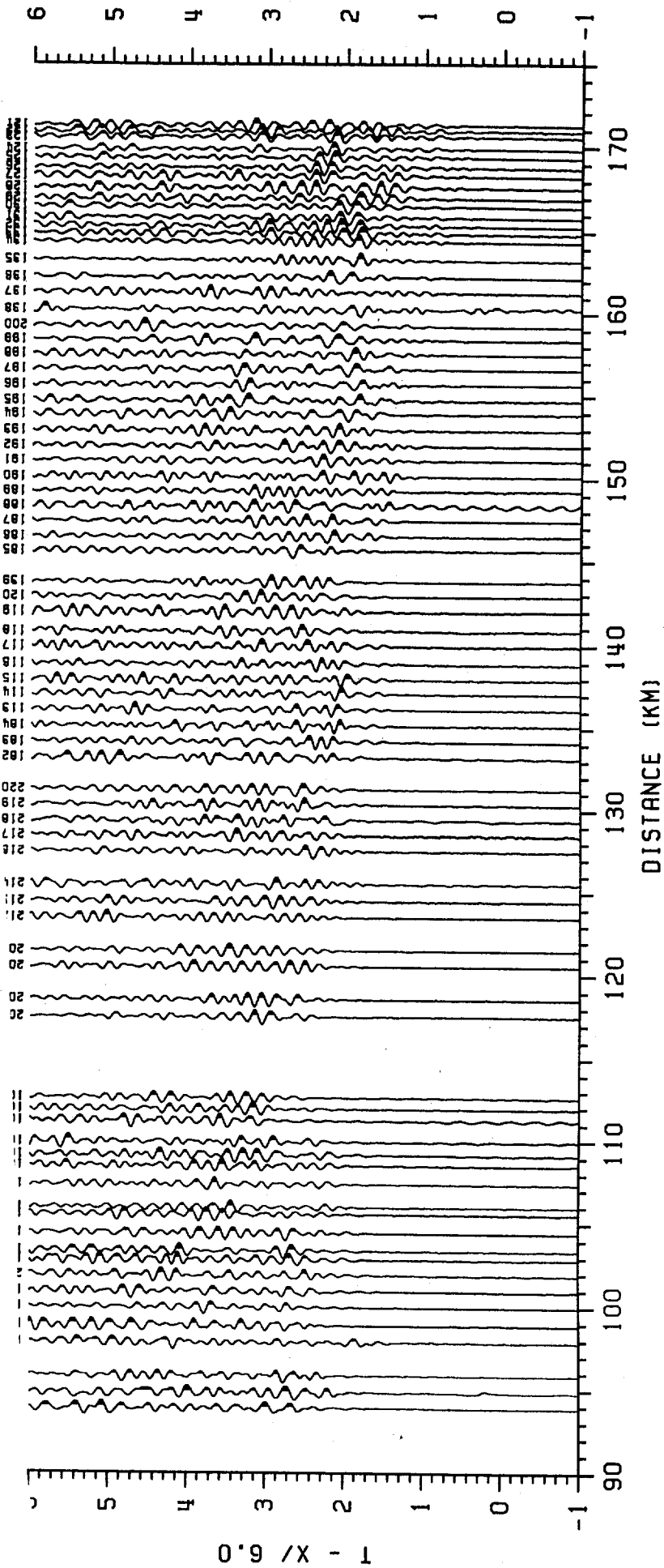

Figure 3. Theoretical transfer-function curves for the USGS short-period seismic refraction system. Solid line: displacement and velocity normalized amplitude; dashed line: phase (displacement). Maximum velocity response is at 6 Hz; maximum displacement response is at 26 Hz (from Dawson and Stauber, 1986, Figure 3).



# SHOTPOINT 1A, SHOTS 3 & 10

FIGURE 4: RECORD SECTION FROM THE 1983 EAST-CENTRAL OREGON SEISMIC SURVEY



# SHOTPOINT 1B, SHOTS 3 & 10

FIGURE 5 : RECORD SECTION FROM THE 1983 EAST-CENTRAL OREGON SEISMIC SURVEY

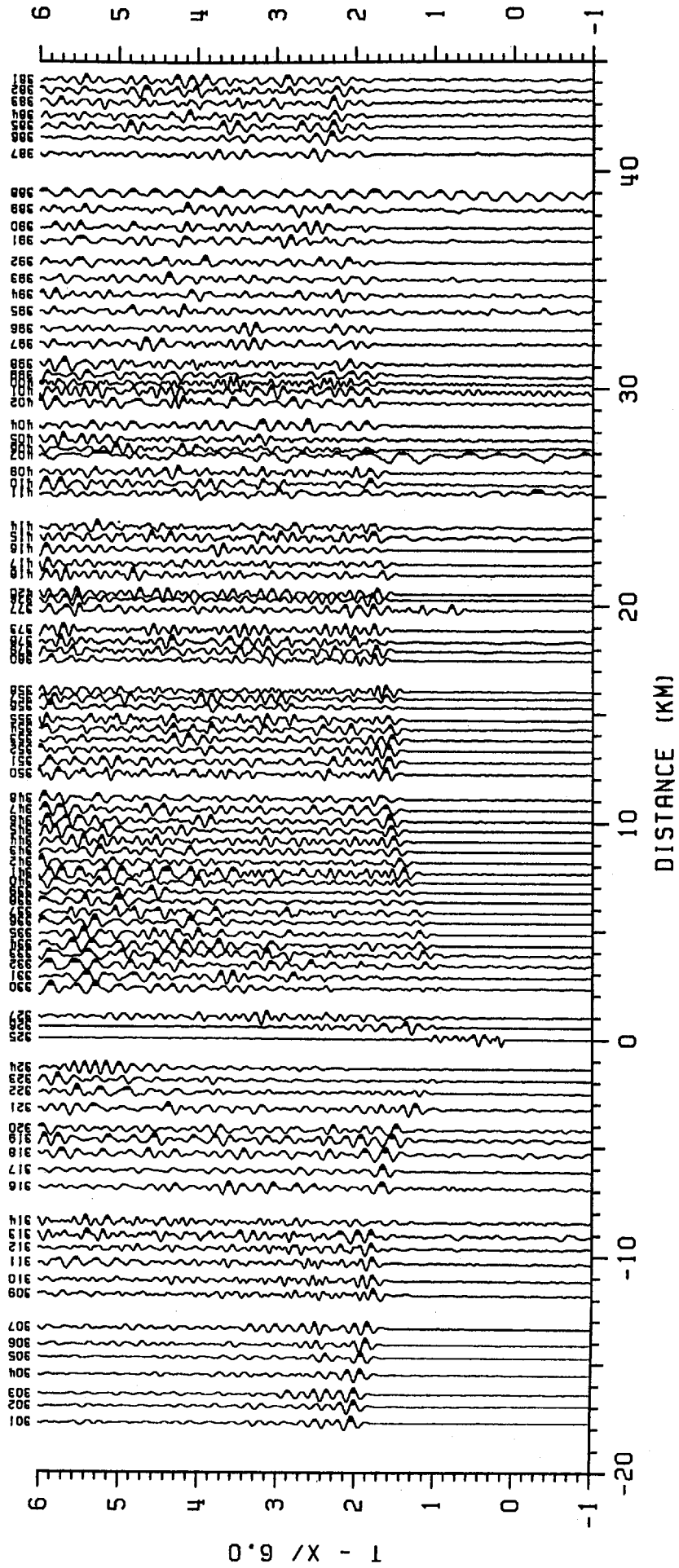

# SHOTPOINT 2, SHOT 7

FIGURE 6 :RECORD SECTION FROM THE 1983 EAST-CENTRAL OREGON SEISMIC SURVEY

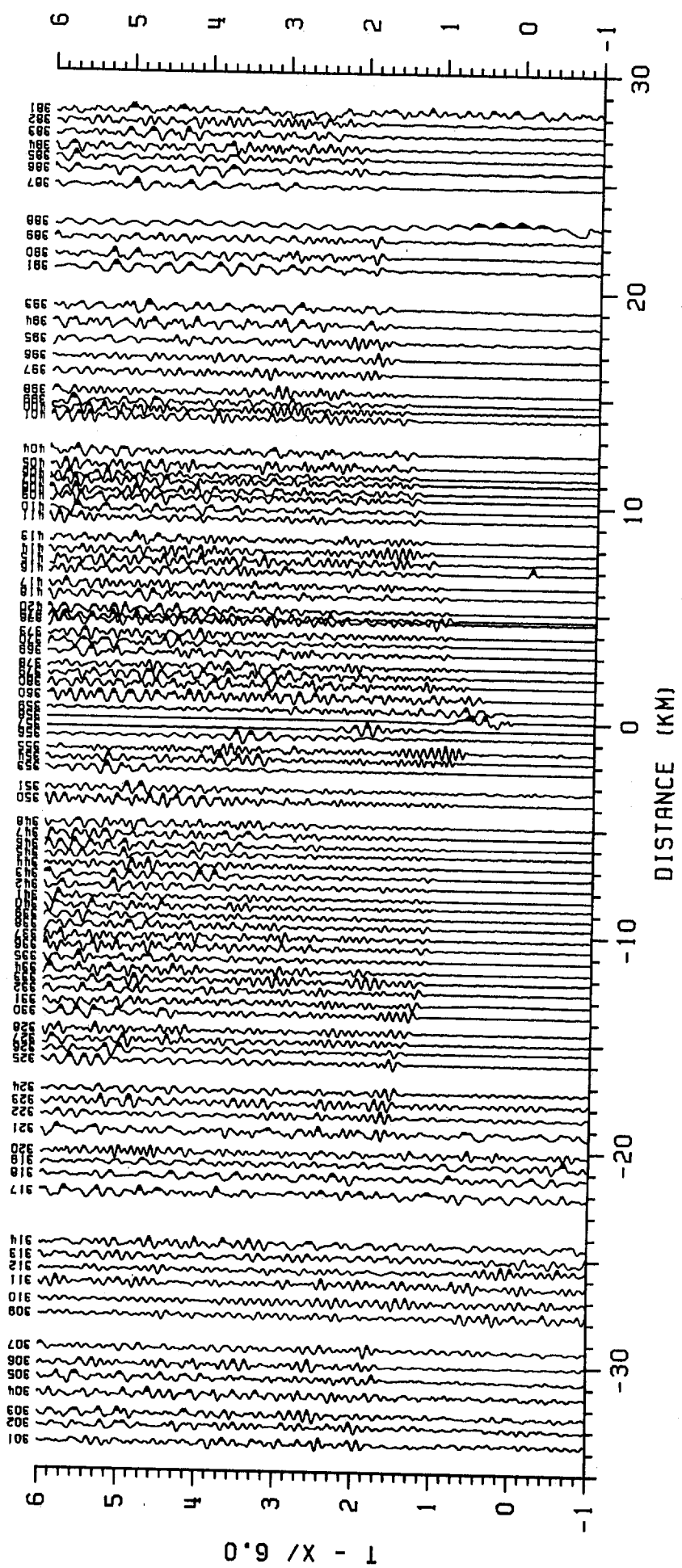

### SHOTPOINT 3, SHOT 4

FIGURE 7 : RECORD SECTION FROM THE 1983 EAST-CENTRAL OREGON SEISMIC SURVEY

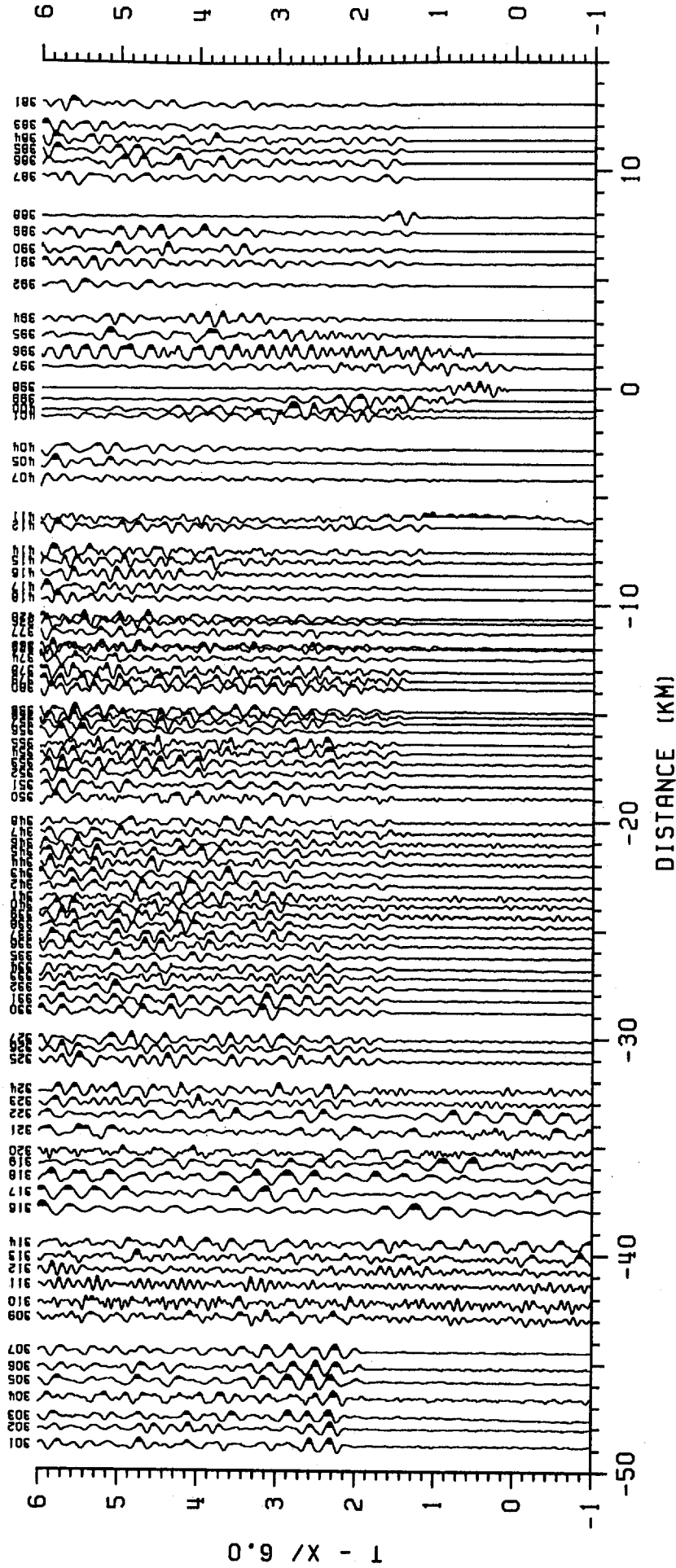

### SHOTPOINT 4, SHOT 6

FIGURE 8: RECORD SECTION FROM THE 1983 EAST-CENTRAL OREGON SEISMIC SURVEY

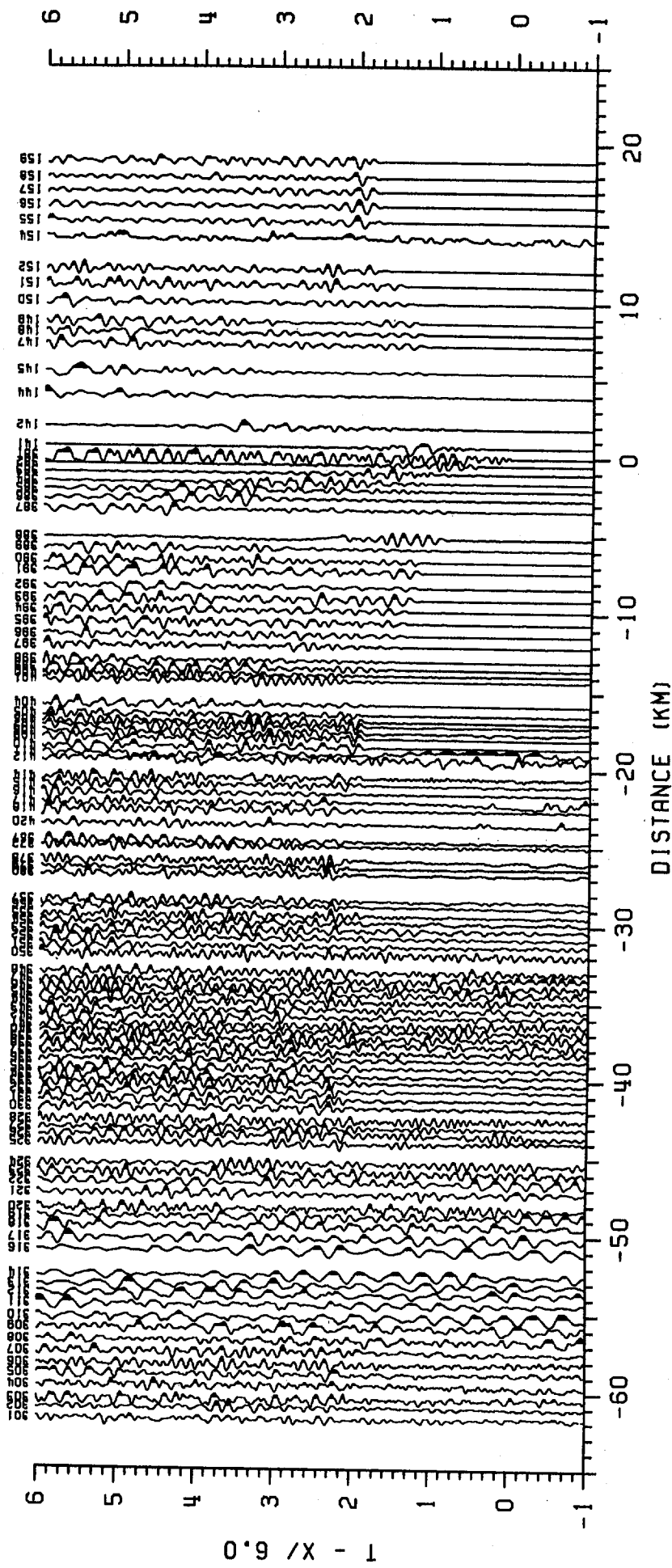

**SHOTPOINT 5A, SHOTS 2 & 8**

FIGURE 9 :RECORD SECTION FROM THE 1983 EAST-CENTRAL OREGON SEISMIC SURVEY

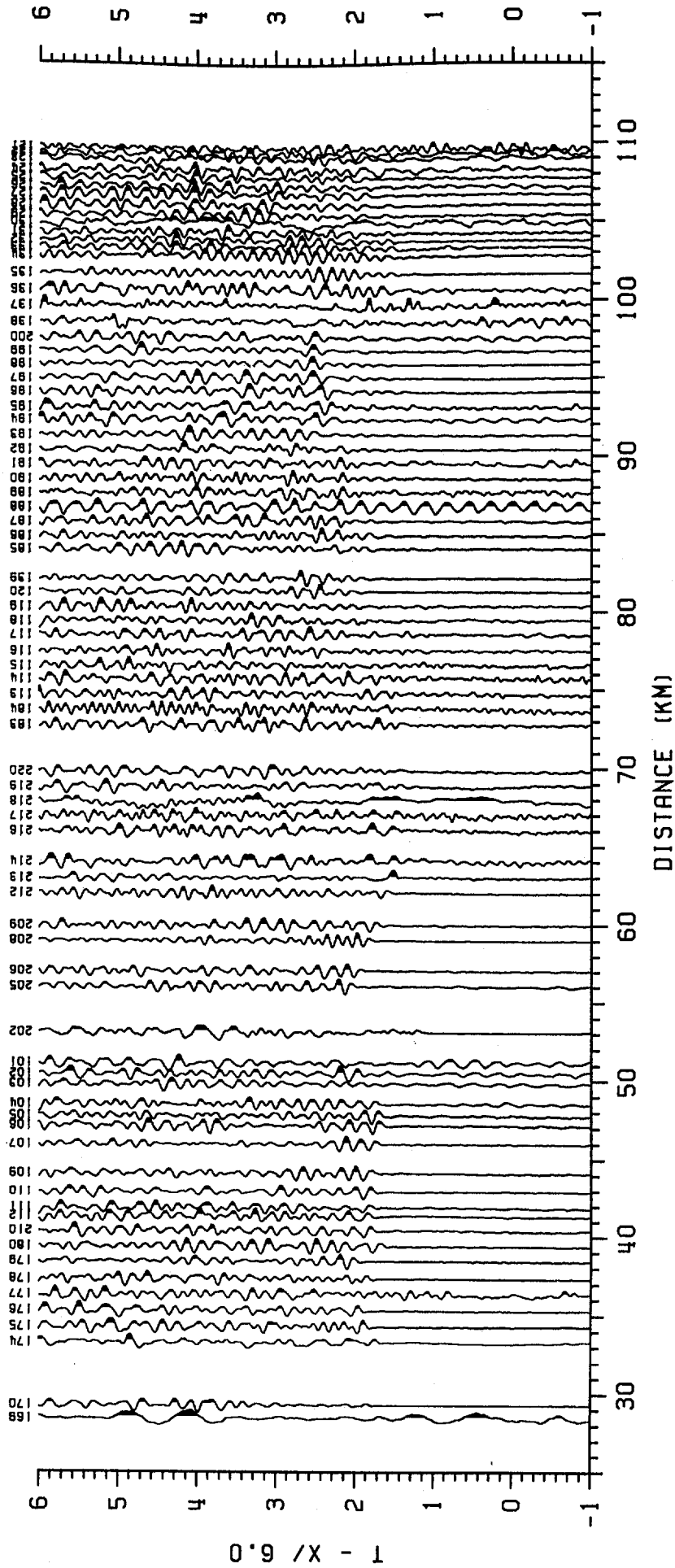

### SHOTPOINT 5B, SHOTS 2 & 8

FIGURE 10: RECORD SECTION FROM THE 1983 EAST-CENTRAL OREGON SEISMIC SURVEY



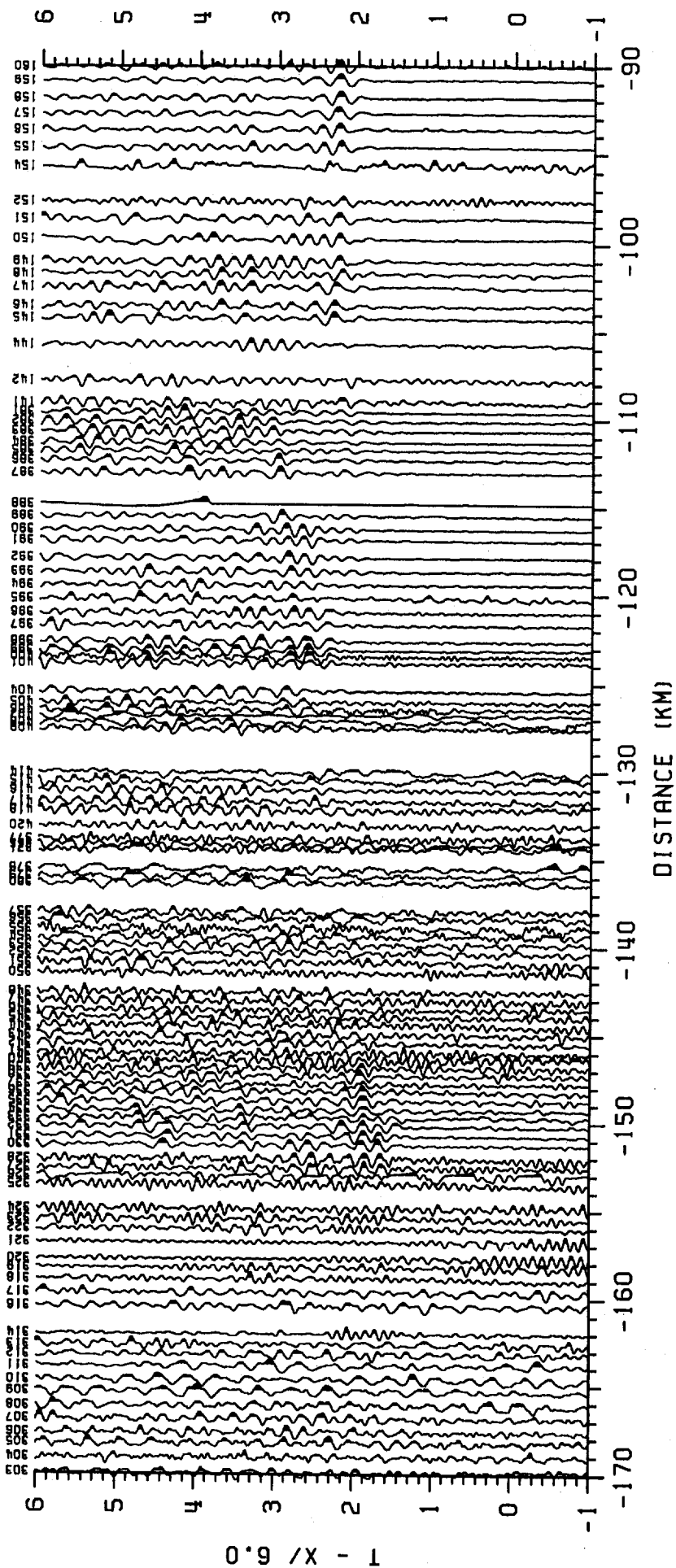

### SHOTPOINT 6A, SHOTS 1 & 9

FIGURE 11: RECORD SECTION FROM THE 1983 EAST-CENTRAL OREGON SEISMIC SURVEY

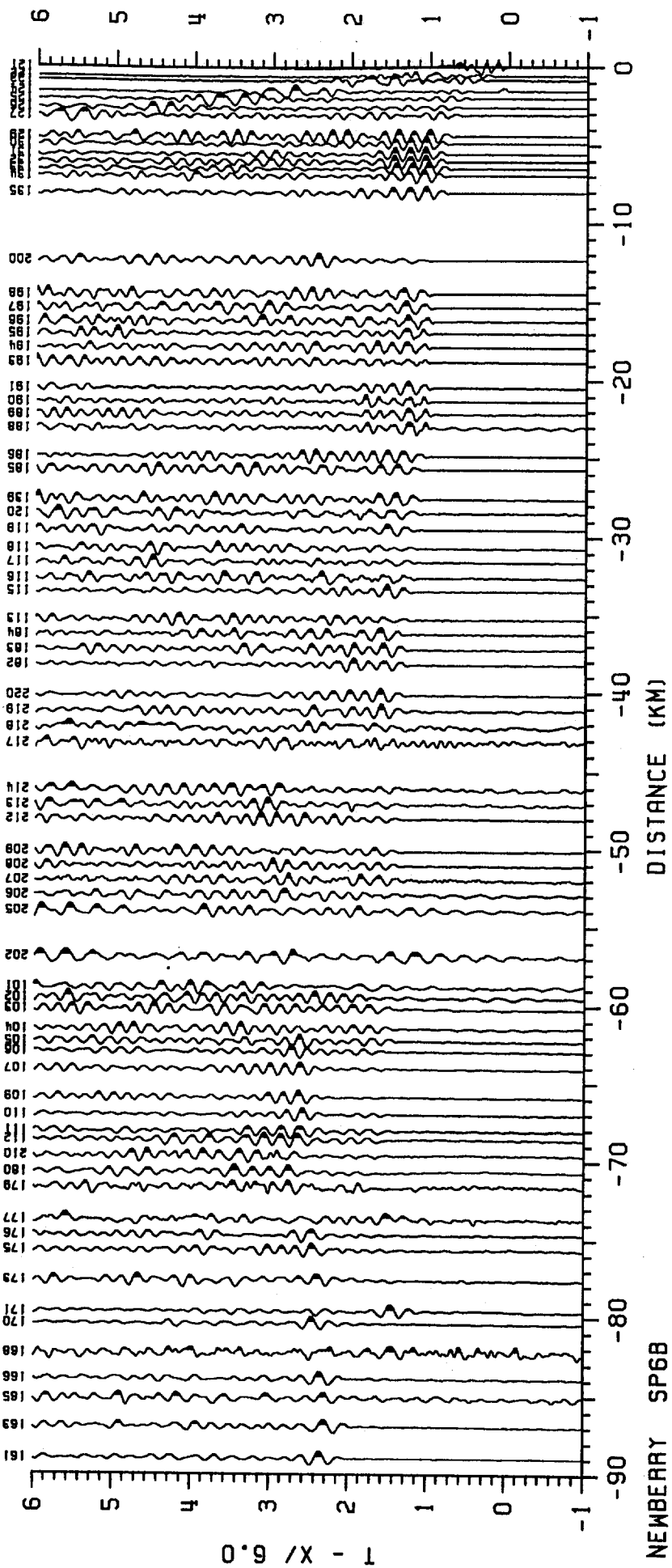

# SHOTPOINT 6B, SHOTS 1 & 9

FIGURE 12 : RECORD SECTION FROM THE 1983 EAST-CENTRAL OREGON SEISMIC SURVEY

MASTER SHOT LIST (SHOT LOCATIONS AND TIMES)

EAST-CENTRAL OREGON 1983

SHOT	SHOTPOINT	DATE	LATITUDE	LONGITUDE	SHOT TIME			
					DAY	HR	MN	SEC
1	6	OCT., 11, 1983	43 36.9633	119 31.2602	284	06	00	00.007
2	5	OCT., 11, 1983	43 41.7366	120 52.7705	284	06	15	00.012
3	1	OCT., 11, 1983	43 42.0076	121 38.8120	284	06	30	00.009
4	3	OCT., 14, 1983	43 42.6363	121 13.7009	287	05	30	00.012
5	7	OCT., 14, 1983	43 39.2523	118 51.3602	287	05	45	00.006
6	4	OCT., 14, 1983	43 41.8559	121 02.4408	287	06	00	00.009
7	2	OCT., 14, 1983	43 42.0996	121 25.5936	287	06	59	59.903
8	5	OCT., 14, 1983	43 41.7366	120 52.7705	287	07	30	00.009
9	6	OCT., 14, 1983	43 36.9633	119 31.2602	287	07	45	00.007
10	1	OCT., 14, 1983	43 42.0076	121 38.8120	287	08	29	59.902

Table 1: Master Shot List. Contains shot number, shotpoint number, date (calendar, Julian), latitude/longitude (degree, minute, and seconds), and shot time (GMT).

APPENDIX ATAPE GRADE CODES

A performance status number is assigned to each field tape as it is digitized. These numbers appear in the last column of the field data file.

- 0 - GOOD
- 1 - TAPE DID NOT RUN
- 2 - TAPE RAN BUT NO SIGNAL
- 3 - TAPE SKIPPED RECORDING TIME
- 4 - TAPE RAN FAST FORWARD;NO SIGNAL
- 5 - TAPE REWOUND AND ERASED
- 6 - WEAK SIGNAL; CANNOT READ THE TIME CODE; LOW RECORD LEVEL
- 7 - NOISE, CONTINUOUS CALIBRATION OR PERIODIC OFFSETS
- 8 - NOISE, SINUSOIDAL
- 9 - NOISE, SPIKE
- 10 - NOISE, WWVB CROSS-FEED
- 11 - NOISE, PERIODIC TICKS
- 12 - NOISE, RANDOM
- 13 - BAD CLOCKS
- 14 - OFF FREQUENCY, TAPE SPEED PROBLEM
- 16 - INCOMPLETE RECORD; RECORDER STOPPED
- 17 - NOISY OR WEAK TIME CODE
- 19 - TURNED ON TO EARLY
- 20 - IN FOR REPAIR; NOT DEPLOYED
- 21 - GEOPHONE DISCONNECTED OR SHORTED
- 22 - WRONG UNIT NUMBER
- 23 - WRONG GAIN SETTING
- 24 - TURNED ON TOO LATE
- 25 - BAD GEOPHONE TEST
- 26 - ONE OR MORE CHANNELS MISSING
- 27 - NOISY OR WEAK WWVB
- 28 - INSTRUMENT OR TAPE MISSING
- 29 - WRONG TIME DURING TURN-ON
- 30 - DIGITIZED W/O CALIBRATION
- 31 - AMPLIFIER OUT OF BALANCE
- 32 - LOCATION NOT ON MAP; WRONG LOCATION

APPENDIX BFIELD DATA TABLES

Field data include information related to the seismic recorders. Each table contains shot number, shotpoint number and shot time given in julian day, hour, minutes and seconds. Column heading for the table are explained below:

LOC	-location number from the seismic recorder.
DIST	-distance in kilometers from the shotpoint to the recorder.
AZIM	-azimuth from the shotpoint to the recorder(degrees clockwise from north).
Db	-attenuation of preferred recording channel (db).
TAPE GRADE	-number corresponding to the performance of each instrument.

## NEWBERRY CRATER

Shot Number 1 Shot Point 6

Shot Time (Julian day, hr, min, sec): 284:06:00:00.007

Loc	Dist (km)	Azim (deg)	Tape Db Grade	Loc	Dist (km)	Azim (deg)	Tape Db Grade	Loc	Dist (km)	Azim (deg)	Tape Db Grade
101	58.82	275.4	12	141	109.08	274.7	12	181	39.22	275.1	
102	59.49	274.6	12	142	107.84	274.8	12	182	38.19	274.3	12
103	60.18	273.9	12	143	106.95	274.8		183	37.21	273.7	12
104	61.47	273.4	12	144	105.78	274.8	12	184	36.23	273.2	12
105	62.28	272.6	12	145	104.29	275.0	12	185	25.70	275.6	12
106	62.92	272.5	12	146	103.60	274.9	12	186	24.87	276.6	12
107	64.08	272.5	12	147	102.52	274.9	12	187	23.97	278.4	
108	65.46	272.8		148	101.77	275.0	12	188	23.04	277.8	12
109	65.89	273.3	12	149	101.05	274.9	12	189	22.15	277.9	12
110	67.01	274.1	12	150	99.79	275.1	12	190	21.31	280.0	30
111	68.06	274.5	12	151	98.61	274.7	12	191	20.45	282.4	30
112	68.61	275.2	12	152	97.64	274.7	12	192	19.58	283.0	
113	35.25	274.5	12	153	96.66	274.8		193	18.79	285.5	30
114	34.27	274.5		154	95.69	274.8	12	194	17.87	286.3	30
115	33.42	274.6	12	155	94.64	274.9	12	195	16.98	285.7	30
116	32.57	278.3	12	156	93.64	274.9	12	196	16.22	288.7	30
117	31.56	279.2	12	157	92.72	274.7	12	197	15.34	289.7	30
118	30.68	279.4	12	158	91.83	274.5	12	198	14.48	290.9	30
119	29.50	279.0	12	159	90.80	274.2	12	199	13.33	287.3	30
120	28.49	276.8	12	160	90.01	274.1	12	200	12.34	285.2	30
121	0.01	340.7	88	161	88.98	274.1	12	201	57.88	276.2	
122	0.56	223.3	88	162	87.79	274.2	12	202	56.89	276.0	30
123	0.84	241.0	88	163	86.94	274.2	12	203	55.92	276.1	
124	1.53	253.7	88	164	86.05	274.3	12	204	54.93	276.2	
125	2.01	256.9	66	165	85.13	274.3	12	205	53.96	276.3	12
126	2.59	259.6	66	166	83.91	274.4	12	206	52.94	276.5	12
127	3.08	260.8	66	167	83.22	274.4	12	207	51.98	277.1	12
128	3.77	262.1		168	82.27	274.5	12	208	51.05	277.7	12
129	4.40	263.2	30	169	81.26	274.5	12	209	50.13	278.3	12
130	4.88	264.0	48	170	80.41	274.6	12	210	69.62	276.0	12
131	5.52	265.3	48	171	79.63	274.7	12	211	49.01	278.0	
132	6.02	265.7		172	78.80	274.7		212	48.02	277.4	12
133	6.46	267.8		173	77.63	274.8	12	213	47.09	278.1	12
134	6.94	269.6		174	76.67	274.7	12	214	46.09	278.6	12
135	8.03	272.7		175	75.66	275.0	12	215	45.17	278.9	
136	9.09	272.5		176	74.68	275.8	12	216	44.15	279.2	
137	10.25	285.8		177	73.68	275.9	12	217	43.18	279.2	12
138	11.22	282.5		178	72.63	275.5		218	42.19	278.4	12
139	27.58	276.0	12	179	71.64	276.7	12	219	41.17	277.3	12
140	26.63	275.3		180	70.65	276.5	12	220	40.16	276.3	12

NEWBERRY CRATER  
 Shot Number 2 Shot Point 5  
 Shot Time (Julian day, hr, min, sec): 284:06:15:00.012

Loc	Dist (km)	Azim (deg)	Tape Db Grade	Loc	Dist (km)	Azim (deg)	Tape Db Grade	Loc	Dist (km)	Azim (deg)	Tape Db Grade
101	51.13	93.7	12	141	0.60	73.7	88	181	70.73	94.4	
102	50.46	94.6	12	142	1.84	83.3	68	182	71.76	94.8	12
103	49.78	95.5	12	143	2.72	86.7		183	72.75	95.1	12
104	48.51	96.1	12	144	3.88	90.4	48	184	73.74	95.3	12
105	47.77	97.2	12	145	5.41	87.0	48	185	84.01	94.3	12
106	47.14	97.4	12	146	6.09	89.4		186	84.85	94.0	12
107	45.99	97.6	12	147	7.16	90.5	48	187	85.79	93.6	12
108	44.58	97.2		148	7.92	89.4	30	188	86.70	93.8	12
109	44.11	96.6	12	149	8.63	90.6	30	189	87.59	93.8	12
110	42.95	95.5	12	150	9.91	89.7	30	190	88.49	93.3	12
111	41.89	94.7	12	151	11.07	94.1	30	191	89.45	92.8	12
112	41.34	93.6	12	152	12.03	93.9	30	192	90.35	92.8	12
113	74.70	94.7	12	153	13.02	93.6		193	91.28	92.4	12
114	75.68	94.6	12	154	13.99	93.3	30	194	92.24	92.4	12
115	76.53	94.6	12	155	15.05	93.1	30	195	93.05	92.6	12
116	77.46	93.1	12	156	16.06	93.1	30	196	94.00	92.2	12
117	78.51	92.8	12	157	16.97	94.2	30	197	94.93	92.2	12
118	79.39	92.8	12	158	17.86	95.4	30	198	95.83	92.2	12
119	80.33	93.0	12	159	18.91	96.5	30	199	96.69	92.9	12
120	81.25	93.8	12	160	19.71	97.1	30	200	97.55	93.3	12
121	109.64	94.6	30	161	20.75	96.8	12	201	52.10	92.9	
122	109.30	94.8	12	162	21.93	96.4		202	53.08	93.1	12
123	108.95	94.9	12	163	22.78	96.2	12	203	54.06	93.1	
124	108.22	94.9	12	164	23.67	95.9	12	204	55.05	93.1	
125	107.74	94.9	12	165	24.59	95.6	12	205	56.02	93.0	12
126	107.16	95.0	30	166	25.81	95.3	12	206	57.05	92.8	12
127	106.67	95.0	12	167	26.50	95.1	12	207	58.03	92.4	
128	105.99	95.0	12	168	27.45	95.0	12	208	59.01	92.0	12
129	105.35	95.1	12	169	28.46	94.8	12	209	59.98	91.5	12
130	104.87	95.1	12	170	29.31	94.6	12	210	40.37	92.2	12
131	104.22	95.1	12	171	30.31	94.5	12	211	61.06	91.9	
132	103.72	95.1	12	172	31.15	94.4		212	62.01	92.4	12
133	103.26	95.0	12	173	32.32	94.2	12	213	62.99	92.0	12
134	102.75	94.9	12	174	33.28	94.4	12	214	64.03	91.7	12
135	101.64	94.8	12	175	34.29	93.7	12	215	64.97	91.6	
136	100.59	94.8	12	176	35.31	92.0	12	216	66.00	91.6	12
137	99.62	93.5	12	177	36.31	92.0	12	217	66.96	91.7	12
138	98.56	93.7	12	178	37.33	92.9	12	218	67.89	92.2	12
139	82.14	94.1	12	179	38.42	90.8	12	219	68.84	93.0	12
140	83.08	94.4		180	39.38	91.2	12	220	69.81	93.7	12

## NEWBERRY CRATER

Shot Number 3 Shot Point 1

Shot Time (Julian day, hr, min, sec): 284:06:30:00.009

Loc	Dist (km)	Azim (deg)	Tape Db Grade	Loc	Dist (km)	Azim (deg)	Tape Db Grade	Loc	Dist (km)	Azim (deg)	Tape Db Grade
101	112.65	91.9	12	141	62.43	90.3	30	181	132.17	92.5	
102	111.95	92.3	12	142	63.69	90.3	12	182	133.18	92.8	12
103	111.25	92.7	12	143	64.58	90.3		183	134.15	93.0	12
104	109.96	93.0	12	144	65.74	90.5		184	135.14	93.1	12
105	109.17	93.4	12	145	67.26	90.2	12	185	145.65	92.7	12
106	108.53	93.4	12	146	67.95	90.4	12	186	146.49	92.5	12
107	107.37	93.5	12	147	69.02	90.5	12	187	147.45	92.3	12
108	105.99	93.3	12	148	69.79	90.3	12	188	148.35	92.4	12
109	105.55	93.0	12	149	70.49	90.5	12	189	149.24	92.4	12
110	104.44	92.5	12	150	71.78	90.4	12	190	150.15	92.1	12
111	103.41	92.2	12	151	72.91	91.0	12	191	151.13	91.9	12
112	102.89	91.7	12	152	73.88	91.0	12	192	152.02	91.9	12
113	136.11	92.8	12	153	74.87	91.0		193	152.97	91.6	12
114	137.09	92.8	12	154	75.84	91.0	12	194	153.92	91.6	12
115	137.94	92.8	12	155	76.90	91.0	12	195	154.73	91.8	12
116	138.91	91.9	12	156	77.91	91.0	12	196	155.69	91.5	12
117	139.97	91.7	12	157	78.81	91.3	12	197	156.61	91.5	12
118	140.85	91.8	12	158	79.68	91.6	12	198	157.52	91.5	12
119	142.00	91.9	12	159	80.47	91.9	12	199	158.37	91.9	12
120	142.89	92.4	12	160	81.26	92.1	12	200	159.22	92.2	12
121	171.26	93.1	12	161	82.30	92.0	12	201	113.63	91.6	
122	170.91	93.3	12	162	83.48	92.0	12	202	114.60	91.7	
123	170.56	93.3	12	163	84.33	92.0	12	203	115.58	91.7	
124	169.83	93.3	12	164	85.23	92.0	12	204	116.56	91.7	
125	169.34	93.3	12	165	86.15	91.9	12	205	117.53	91.7	12
126	168.76	93.3	30	166	87.37	91.9	12	206	118.56	91.6	12
127	168.27	93.3	12	167	88.06	91.9	12	207	119.55	91.4	
128	167.59	93.4	12	168	89.02	91.9	12	208	120.53	91.2	12
129	166.95	93.4	12	169	90.02	91.8	12	209	121.50	91.0	12
130	166.47	93.4	12	170	90.88	91.8	12	210	101.94	91.2	12
131	165.82	93.4	12	171	91.88	91.8	12	211	122.58	91.2	
132	165.32	93.4	12	172	92.71	91.8	12	212	123.51	91.4	12
133	164.86	93.3	12	173	93.88	91.7	12	213	124.49	91.3	12
134	164.36	93.3	12	174	94.83	91.8	12	214	125.53	91.1	12
135	163.25	93.1	12	175	95.86	91.6	12	215	126.47	91.0	
136	162.20	93.2	12	176	96.89	91.0	12	216	127.50	91.0	12
137	161.28	92.3	12	177	97.89	91.0	12	217	128.46	91.1	12
138	160.21	92.5	12	178	98.90	91.4	12	218	129.38	91.4	12
139	143.78	92.6	12	179	100.00	90.6	12	219	130.32	91.8	12
140	144.71	92.7		180	100.96	90.8	12	220	131.27	92.2	12



## NEWBERRY CRATER

Shot Number 4 Shot Point 3

Shot Time (Julian day, hr, min, sec): 287:05:30:00.012

Loc	Dist (km)	Azim (deg)	Tape		Loc	Dist (km)	Azim (deg)	Tape		Loc	Dist (km)	Azim (deg)	Tape	
---	---	---	Db	Grade	---	---	---	Db	Grade	---	---	---	Db	Grade
301	33.72	268.1			341	8.36	268.5	30		381	28.20	93.3		
302	32.95	268.5			342	7.85	265.9	30		382	27.69	93.0		
303	32.40	268.5			343	7.36	266.0	30		383	27.14	92.9		
304	31.48	269.6			344	6.88	263.3	48		384	26.52	93.0		
305	30.71	269.0			345	6.39	263.8	30		385	26.03	93.1		
306	30.08	269.2			346	5.95	264.6	30		386	25.48	92.5		
307	29.34	268.5			347	5.44	264.9	30		387	24.77	92.9		
308	28.61	268.5			348	4.94	263.8	30		388	22.98	92.2		
309	27.79	268.4			349	4.43	265.6			389	22.28	93.2		
310	27.13	268.3			350	3.80	265.9	30		390	21.50	94.7		
311	26.31	268.3			351	3.25	263.9	68		391	20.91	96.3	12	
312	25.65	268.2			352	2.78	255.8			392	19.90	96.3		
313	25.06	268.3			353	2.32	251.8	68		393	19.11	96.4	12	
314	24.43	268.3			354	1.84	249.3	68		394	18.35	95.6	12	
315	23.57	269.1			355	1.40	246.5	88		395	17.55	93.8	12	
316	22.85	268.4			356	0.78	242.3	88		396	16.77	94.4	12	
317	22.09	267.8	12		357	0.38	233.5	88		397	16.07	94.3	12	
318	21.29	268.9	12		358	0.04	77.8	88		398	15.16	95.6	12	
319	20.70	267.7	12		359	0.45	46.3	88		399	14.68	96.5	12	
320	20.20	267.6	30		360	1.02	49.8	30		400	14.33	97.7	12	
321	19.24	267.5	12		361	3.84	40.7	30		401	13.95	97.6	12	
322	18.47	267.5	12		362	3.67	49.0	30		402	13.42	97.2		
323	17.88	267.9	12		363	3.41	54.2	30		403	12.91	95.9		
324	17.32	267.6	12		364	3.43	65.9	48		404	12.35	96.2	12	
325	15.98	266.5	12		365	3.60	73.7	48		405	11.71	96.6	30	
326	15.45	266.5	30		366	3.66	80.7	48		406	11.26	97.0	30	
327	15.01	266.2	30		367	3.48	88.6	48		407	10.97	97.6	30	
328	14.51	266.5	30		368	3.24	95.9	48		408	10.57	98.7	12	
329	14.01	267.3			369	3.04	99.7	48		409	10.25	99.8	30	
330	13.70	266.5	30		370	3.51	108.3	48		410	9.73	101.3	30	
331	13.18	266.1	30		371	3.69	118.5	48		411	9.31	102.0	30	
332	12.64	265.5	30		372	3.78	124.4	48		412	8.93	103.1		
333	12.17	264.2	30		373	3.91	134.0	48		413	8.36	104.0	30	
334	11.71	265.4	30		374	4.34	140.2			414	7.80	104.5	30	
335	11.18	265.8	30		375	4.70	142.5	48		415	7.35	105.4	30	
336	10.64	265.4	30		376	4.55	110.1	48		416	6.90	108.9	48	
337	10.18	266.2	30		377	4.05	109.6	48		417	6.22	109.0	30	
338	9.67	267.1	30		378	2.43	68.9	48		418	5.74	109.6	48	
339	9.24	266.1	30		379	2.02	65.0	68		419	5.44	114.2		
340	8.78	266.6	30		380	1.59	63.6	88		420	5.06	116.9	48	

## NEWBERRY CRATER

Shot Number 5 Shot Point 7

Shot Time (Julian day, hr, min, sec): 287:05:45:00.006

Loc	Dist (km)	Azim (deg)	Tape Db Grade	Loc	Dist (km)	Azim (deg)	Tape Db Grade	Loc	Dist (km)	Azim (deg)	Tape Db Grade
301	224.45	271.3	12	341	199.19	271.7	12	381	162.75	271.6	12
302	223.69	271.4	12	342	198.66	271.6	12	382	163.26	271.7	12
303	223.14	271.4	12	343	198.17	271.7	12	383	163.81	271.7	12
304	222.24	271.5	12	344	197.66	271.6	12	384	164.43	271.7	12
305	221.47	271.5	12	345	197.18	271.6	12	385	164.92	271.7	12
306	220.84	271.5	12	346	196.75	271.7	12	386	165.45	271.8	12
307	220.09	271.4	12	347	196.25	271.7	12	387	166.17	271.7	12
308	219.36	271.4		348	195.75	271.7	12	388	167.95	271.8	
309	218.54	271.4	12	349	195.26	271.7		389	168.66	271.7	
310	217.89	271.4	12	350	194.64	271.8	12	390	169.46	271.5	12
311	217.07	271.4	12	351	194.07	271.7	12	391	170.10	271.3	12
312	216.40	271.4	12	352	193.53	271.6	12	392	171.10	271.4	12
313	215.82	271.5	12	353	193.04	271.6	30	393	171.89	271.4	12
314	215.20	271.5	12	354	192.57	271.7	68	394	172.62	271.5	12
315	214.35	271.6		355	192.12	271.7	30	395	173.38	271.7	12
316	213.63	271.5		356	191.54	271.8	30	396	174.16	271.6	12
317	212.86	271.5	12	357	191.16	271.8	12	397	174.86	271.7	12
318	212.08	271.6	30	358	190.81	271.9	12	398	175.79	271.6	12
319	211.47	271.5	30	359	190.54	272.0	12	399	176.29	271.5	12
320	210.97	271.5	30	360	190.09	272.1	12	400	176.67	271.4	12
321	210.01	271.5	30	361	188.44	272.8	12	401	177.04	271.4	12
322	209.25	271.5	30	362	188.15	272.6	12	402	177.56	271.5	
323	208.66	271.5	12	363	188.15	272.5	12	403	178.03	271.6	
324	208.10	271.5	12	364	187.77	272.3	12	404	178.59	271.6	30
325	206.74	271.5	12	365	187.43	272.2	12	405	179.23	271.6	12
326	206.22	271.5	12	366	187.27	272.1	12	406	179.69	271.6	
327	205.77	271.5	12	367	187.39	271.9	12	407	179.99	271.5	12
328	205.29	271.5	12	368	187.64	271.8		408	180.42	271.5	12
329	204.80	271.6		369	187.86	271.7	12	409	180.76	271.4	12
330	204.48	271.5	12	370	187.52	271.6	12	410	181.32	271.4	12
331	203.96	271.5	12	371	187.60	271.4	12	411	181.75	271.4	12
332	203.40	271.5	12	372	187.72	271.3	12	412	182.15	271.3	12
333	202.91	271.4	12	373	188.02	271.1	12	413	182.74	271.3	12
334	202.49	271.5	12	374	188.05	270.9	12	414	183.30	271.3	12
335	201.96	271.5	12	375	187.97	270.8	12	415	183.77	271.3	12
336	201.42	271.5	12	376	186.57	271.4	12	416	184.32	271.2	12
337	200.97	271.6	12	377	187.03	271.5	12	417	184.96	271.3	12
338	200.48	271.6	12	378	188.61	272.2	12	418	185.44	271.3	12
339	200.04	271.6	12	379	189.05	272.2	12	419	185.88	271.2	
340	199.59	271.6	12	380	189.45	272.1	12	420	186.33	271.2	12

NEWBERRY CRATER  
 Shot Number 6 Shot Point 4  
 Shot Time (Julian day, hr, min, sec): 287:06:00:00.009

Loc	Dist (km)	Azim (deg)	Tape Db Grade	Loc	Dist (km)	Azim (deg)	Tape Db Grade	Loc	Dist (km)	Azim (deg)	Tape Db Grade
301	48.84	270.4	12	341	23.52	273.0	12	381	13.03	90.8	30
302	48.08	270.7	12	342	22.98	272.2	12	382	12.53	90.1	30
303	47.52	270.7	12	343	22.49	272.4	30	383	11.98	89.6	30
304	46.63	271.5	12	344	21.97	271.7	30	384	11.36	89.7	30
305	45.85	271.1	12	345	21.49	272.0	30	385	10.86	89.8	30
306	45.22	271.3	12	346	21.07	272.4	30	386	10.34	88.2	30
307	44.46	270.9	12	347	20.56	272.7	30	387	9.61	88.9	30
308	43.73	270.9		348	20.06	272.6	30	388	7.86	85.8	30
309	42.91	270.9	12	349	19.58	273.2		389	7.12	88.3	30
310	42.25	270.9	30	350	18.96	273.6	30	390	6.31	92.9	30
311	41.43	270.9	30	351	18.39	273.4	30	391	5.71	98.4	48
312	40.77	270.9	12	352	17.84	272.5	30	392	4.71	98.9	48
313	40.18	271.0	12	353	17.35	272.4	30	393	3.93	99.9	
314	39.56	271.0	12	354	16.87	272.7	12	394	3.16	96.4	68
315	38.72	271.6		355	16.43	273.1	30	395	2.40	83.6	68
316	37.98	271.2	12	356	15.86	273.9	30	396	1.60	84.2	30
317	37.21	270.9	12	357	15.48	274.5	30	397	0.93	75.3	88
318	36.43	271.6	12	358	15.15	275.5	30	398	0.04	234.1	88
319	35.82	271.0	30	359	14.91	276.8	30	399	0.58	249.0	88
320	35.32	271.0	30	360	14.50	278.3	30	400	1.05	242.4	88
321	34.36	271.0		361	13.35	289.1	30	401	1.36	253.4	68
322	33.59	271.1		362	12.94	287.3	30	402	1.83	262.5	
323	33.00	271.4		363	12.83	285.6	30	403	2.28	273.0	
324	32.44	271.3		364	12.33	283.3	30	404	2.85	272.4	68
325	31.08	270.9		365	11.92	281.9	48	405	3.49	271.6	48
326	30.55	271.0		366	11.70	280.0	30	406	3.95	271.2	
327	30.11	270.9		367	11.75	277.5	30	407	4.25	269.9	48
328	29.62	271.1		368	11.96	275.3	30	408	4.69	268.0	
329	29.13	271.5		369	12.17	274.4	48	409	5.04	266.6	
330	28.82	271.2	12	370	11.80	271.7	48	410	5.61	265.3	
331	28.29	271.1	12	371	11.89	268.5	48	411	6.05	265.3	12
332	27.73	270.9	12	372	12.03	266.7	48	412	6.45	264.9	48
333	27.24	270.5	12	373	12.38	264.1	30	413	7.04	265.3	
334	26.81	271.1	12	374	12.50	261.3	30	414	7.59	266.2	48
335	26.29	271.3	12	375	12.48	259.4	30	415	8.06	266.4	48
336	25.74	271.3	12	376	10.85	269.4	48	416	8.64	264.8	48
337	25.30	271.8	12	377	11.31	270.4	48	417	9.26	266.4	48
338	24.81	272.2	12	378	13.06	280.2	30	418	9.74	267.2	48
339	24.36	271.9	12	379	13.49	279.8	12	419	10.20	265.6	
340	23.91	272.2	12	380	13.87	278.9	12	420	10.66	265.5	48

## NEWBERRY CRATER

Shot Number 7 Shot Point 2

Shot Time (Julian day, hr, min, sec): 287:06:59:59.903

Loc	Dist (km)	Azim (deg)	Tape Db Grade	Loc	Dist (km)	Azim (deg)	Tape Db Grade	Loc	Dist (km)	Azim (deg)	Tape Db Grade
301	17.73	269.6	30	341	7.66	84.2	12	381	44.14	90.8	12
302	16.97	270.5	30	342	8.16	87.0	30	382	43.64	90.6	12
303	16.41	270.5	30	343	8.65	86.8	30	383	43.08	90.5	12
304	15.52	272.8	30	344	9.15	88.8	30	384	42.46	90.5	12
305	14.74	271.7	30	345	9.63	88.2	30	385	41.97	90.6	12
306	14.12	272.3	30	346	10.07	87.5	30	386	41.44	90.2	12
307	13.35	270.9	30	347	10.58	87.2	30	387	40.72	90.4	12
308	12.63	271.0		348	11.07	87.6	30	388	38.94	89.8	30
309	11.80	271.0	30	349	11.58	86.8		389	38.22	90.4	12
310	11.14	271.0	30	350	12.20	86.6	30	390	37.42	91.2	12
311	10.32	271.3	30	351	12.76	87.1	30	391	36.78	92.0	12
312	9.66	271.0	30	352	13.29	88.6	30	392	35.78	91.9	12
313	9.08	271.6	12	353	13.78	88.9	30	393	34.99	91.8	12
314	8.45	271.8	12	354	14.26	88.6	12	394	34.25	91.3	12
315	7.62	274.7		355	14.70	88.3	12	395	33.49	90.3	12
316	6.88	273.1	30	356	15.30	87.6	30	396	32.70	90.5	12
317	6.11	271.5	30	357	15.69	87.2	30	397	32.00	90.4	12
318	5.35	276.3	30	358	16.05	86.4	30	398	31.07	90.9	12
319	4.71	271.8	30	359	16.35	85.4	12	399	30.57	91.2	12
320	4.21	272.0	30	360	16.84	84.4	30	400	30.19	91.8	12
321	3.25	272.7		361	18.89	78.1	12	401	29.82	91.6	12
322	2.48	274.7		362	19.05	79.7	12	402	29.30	91.4	12
323	1.92	280.1	68	363	18.98	80.9	12	403	28.83	90.7	
324	1.35	281.8	88	364	19.26	82.9	12	404	28.26	90.7	12
325	0.03	69.3	88	365	19.54	84.1	30	405	27.62	90.7	12
326	0.56	83.9	88	366	19.65	85.4	12	406	27.16	90.8	12
327	1.00	90.0	88	367	19.49	86.8	12	407	26.86	91.0	12
328	1.50	86.3		368	19.21	88.0	30	408	26.43	91.3	
329	2.01	80.4		369	18.98	88.6	30	409	26.09	91.6	12
330	2.30	85.8	68	370	19.31	90.3	30	410	25.53	92.1	12
331	2.83	87.9	68	371	19.24	92.3		411	25.10	92.2	12
332	3.38	90.0	68	372	19.13	93.4	30	412	24.70	92.4	
333	3.88	93.4	68	373	18.87	95.2	30	413	24.12	92.5	
334	4.30	89.2	30	374	18.90	97.1	30	414	23.55	92.3	12
335	4.83	88.0	30	375	19.04	98.3	30	415	23.08	92.4	12
336	5.37	88.6	30	376	20.26	91.6	30	416	22.54	93.2	12
337	5.83	86.8	30	377	19.80	91.1	30	417	21.89	92.7	30
338	6.34	85.4	30	378	18.34	84.1	30	418	21.40	92.5	30
339	6.77	87.0	30	379	17.90	84.1	12	419	20.98	93.4	
340	7.23	86.2	30	380	17.48	84.4	12	420	20.53	93.6	30

## NEWBERRY CRATER

Shot Number 8 Shot Point 5

Shot Time (Julian day, hr, min, sec): 287:07:30:00.009

Loc	Dist (km)	Azim (deg)	Tape		Loc	Dist (km)	Azim (deg)	Tape		Loc	Dist (km)	Azim (deg)	Tape	
			Db	Grade				Db	Grade				Db	Grade
301	61.83	270.5			341	36.51	272.3	12		381	0.05	52.9	12	
302	61.07	270.8	12		342	35.97	271.8	12		382	0.50	292.8	88	
303	60.52	270.8	12		343	35.48	271.9	12		383	1.06	287.0	88	
304	59.62	271.4	12		344	34.96	271.4	12		384	1.66	279.8	68	
305	58.84	271.1	12		345	34.49	271.6	12		385	2.15	277.1	68	
306	58.22	271.2	12		346	34.06	271.9	12		386	2.72	281.8	68	
307	57.46	270.9	12		347	33.56	272.0	12		387	3.41	276.7	68	
308	56.73	270.9	12		348	33.05	272.0	12		388	5.22	278.8	48	
309	55.91	270.9	12		349	32.57	272.3			389	5.89	274.2	48	
310	55.25	270.9	12		350	31.95	272.5	12		390	6.69	269.2	30	
311	54.43	270.9	12		351	31.38	272.4	12		391	7.37	265.2	30	
312	53.76	270.9	12		352	30.83	271.8	12		392	8.36	266.5	48	
313	53.18	271.0	12		353	30.34	271.8	12		393	9.14	267.2	30	
314	52.56	271.0	12		354	29.86	271.9	12		394	9.86	269.2	30	
315	51.71	271.4			355	29.42	272.2	12		395	10.62	272.6	30	
316	50.98	271.2	12		356	28.84	272.6	12		396	11.41	271.9	30	
317	50.21	271.0	12		357	28.46	272.9	12		397	12.11	272.2	30	
318	49.43	271.5	12		358	28.13	273.4	12		398	13.03	270.9	30	
319	48.82	271.0	30		359	27.86	274.1	12		399	13.54	270.1	30	
320	48.31	271.0	30		360	27.43	274.9	12		400	13.92	268.9	30	
321	47.35	271.0	30		361	26.01	280.1	12		401	14.29	269.3	30	
322	46.58	271.1	12		362	25.67	279.1	30		402	14.81	269.9		
323	46.00	271.3	12		363	25.61	278.2	30		403	15.28	271.3		
324	45.43	271.2	12		364	25.17	277.0	30		404	15.84	271.2	12	
325	44.07	270.9	12		365	24.80	276.2	30		405	16.49	271.1	30	
326	43.55	271.0	30		366	24.61	275.3	12		406	16.94	271.0	30	
327	43.10	270.9	12		367	24.70	274.1	12		407	17.25	270.7	30	
328	42.61	271.0	12		368	24.93	273.1	30		408	17.68	270.2	12	
329	42.12	271.4			369	25.15	272.6	30		409	18.02	269.8	12	
330	41.81	271.2	12		370	24.80	271.3	30		410	18.59	269.3	12	
331	41.28	271.1	12		371	24.88	269.8	12		411	19.02	269.2	12	
332	40.72	270.9	12		372	25.01	268.9	30		412	19.42	269.0	12	
333	40.23	270.6	12		373	25.33	267.6	30		413	20.01	269.0		
334	39.81	271.1	12		374	25.40	266.2	12		414	20.57	269.2	12	
335	39.28	271.2	12		375	25.35	265.3	12		415	21.04	269.2	12	
336	38.74	271.2	12		376	23.84	270.2	30		416	21.61	268.5	30	
337	38.29	271.5	12		377	24.31	270.7	30		417	22.24	269.1	30	
338	37.80	271.8	12		378	25.97	275.6	12		418	22.72	269.3	30	
339	37.35	271.6	12		379	26.41	275.5	12		419	23.17	268.6		
340	36.90	271.8	12		380	26.80	275.1	12		420	23.62	268.5	30	

## NEWBERRY CRATER

Shot Number 9 Shot Point 6

Shot Time (Julian day, hr, min, sec): 287:07:45:00.007

Loc	Dist (km)	Azim (deg)	Tape Db Grade	Loc	Dist (km)	Azim (deg)	Tape Db Grade	Loc	Dist (km)	Azim (deg)	Tape Db Grade
301	171.23	273.1	12	341	146.04	274.0	12	381	109.61	274.6	12
302	170.49	273.2	12	342	145.49	273.9	12	382	110.12	274.7	12
303	169.93	273.2	12	343	145.00	273.9	12	383	110.68	274.7	12
304	169.06	273.5	12	344	144.48	273.8	12	384	111.29	274.7	12
305	168.27	273.4	12	345	144.01	273.9	12	385	111.78	274.7	12
306	167.65	273.4	12	346	143.59	274.0	12	386	112.33	274.8	12
307	166.89	273.3	12	347	143.09	274.0	12	387	113.04	274.7	12
308	166.16	273.3	12	348	142.59	274.0	12	388	114.83	274.8	48
309	165.34	273.4	12	349	142.11	274.1		389	115.52	274.6	12
310	164.69	273.4	12	350	141.49	274.1	12	390	116.29	274.3	12
311	163.87	273.4	12	351	140.92	274.1	12	391	116.90	274.0	12
312	163.21	273.4	12	352	140.37	274.0	12	392	117.91	274.0	12
313	162.63	273.4	12	353	139.88	274.0	12	393	118.69	274.0	12
314	162.01	273.5	12	354	139.41	274.0	12	394	119.44	274.2	12
315	161.17	273.6		355	138.97	274.1	12	395	120.23	274.4	12
316	160.44	273.5	12	356	138.40	274.2	12	396	121.01	274.4	12
317	159.66	273.5	12	357	138.02	274.3	12	397	121.71	274.4	12
318	158.90	273.6	30	358	137.69	274.4	12	398	122.62	274.2	12
319	158.28	273.5	30	359	137.43	274.5	12	399	123.11	274.1	12
320	157.78	273.5	30	360	137.00	274.7	12	400	123.48	274.0	12
321	156.82	273.5	30	361	135.47	275.7	12	401	123.85	274.0	12
322	156.06	273.6	30	362	135.16	275.5	12	402	124.38	274.1	
323	155.48	273.6	30	363	135.13	275.3	12	403	124.86	274.2	
324	154.91	273.6	12	364	134.72	275.1	12	404	125.42	274.2	12
325	153.55	273.5	12	365	134.36	274.9	12	405	126.07	274.2	12
326	153.02	273.6	12	366	134.18	274.7	12	406	126.52	274.1	12
327	152.58	273.6	12	367	134.27	274.5	12	407	126.81	274.1	12
328	152.10	273.6	12	368	134.50	274.3	12	408	127.24	274.0	
329	151.62	273.7		369	134.72	274.2	30	409	127.57	273.9	
330	151.30	273.7	12	370	134.35	274.0	30	410	128.12	273.8	
331	150.77	273.6	12	371	134.39	273.7	30	411	128.55	273.8	
332	150.21	273.6	12	372	134.50	273.6	12	412	128.94	273.8	
333	149.71	273.5	12	373	134.77	273.3	30	413	129.53	273.7	
334	149.30	273.7	12	374	134.78	273.0	12	414	130.09	273.8	12
335	148.78	273.7	12	375	134.68	272.9	12	415	130.56	273.7	12
336	148.24	273.7	12	376	133.38	273.8	12	416	131.10	273.6	12
337	147.80	273.8	12	377	133.85	273.9	12	417	131.75	273.7	12
338	147.32	273.9	12	378	135.54	274.8	12	418	132.24	273.7	12
339	146.87	273.8	12	379	135.97	274.8	12	419	132.66	273.6	
340	146.42	273.9	12	380	136.36	274.7	12	420	133.11	273.5	12

APPENDIX C

## Archive Data Tape Format

Archive data tapes are written SEG Y standard format (Barry et al,1975). Recording density is 1600 bpi, phase encoded (PE). In order to accommodate seismic refraction data, some minor changes have been made to the tape header fields. A complete list of the header fields is provided in the card image portion of the reel identification header, shown below:

C 1 REEL IDENTIFICATION HEADER BYTES:  
 C 2 3217 -3218 sampling interval (microsecs).  
 C 3 3221 -3222 number of the sample per trace.  
 C 4 3225 -3226 data sample format code.  
 C 5 3255 -3256 measurement system (1 = meters; 2 = feet).  
 C 6  
 C 7  
 C 8 TRACE IDENTIFICATION HEADERS BYTES:  
 C 9 1 - 4 trace sequence number within reel.  
 C10 5 - 8 trace sequence number within reels.  
 C11 9 - 12 station location numbers.  
 C12 29 - 30 trace ID code (1 = seismic data).  
 C13 37 - 40 shotpoint- receiver distance (M).  
 C14 41 - 44 station elevation (M).  
 C15 45 - 48 shotpoint elevations (M).  
 C16 49 - 52 source depth (M).  
 C17 69 - 70 scalar to be applied to all elevations.  
 C18 71 - 72 scalar to be applied to all coordinates.  
 C19 73 - 76 shotpoint coordinated -X.  
 C20 77 - 80 shotpoint coordinates -Y.  
 C21 81 - 84 receiver coordinates -X.  
 C22 85 - 88 receiver coordinates -Y.  
 C23 89 - 90 coordinate units (1 = meters; 2 = seconds of arc).  
 C24 115 -116 number of samples in this trace.  
 C25 117 -118 sample interval in microseconds for this trace.  
 C26 121 -122 instrument attenuation in db.  
 C27 157 -158 shot time - year.  
 C28 159 -160 shot time - day of year.  
 C29 161 -162 shot time - hour of the day( 24 hour clock).  
 C30 163 -164 shot time - minute of the hour.  
 C31 165 -166 shot time - second of minute.  
 C32 167 -168 time basis code (2 = GMT).  
 C33 181 -182 shot time - milliseconds.  
 C34 183 -184 shotpoint location number.  
 C35 185 -186 recording instrument unit number.

C36 191 -192 distance weighting exponent (hundredths).  
C37 193 -194 shot sequence number (shot number).  
C38 195 -196 shot size (kg).  
C39 197 -200 shot point - station azimuth (second of arc).  
C40 201 -204 time of first point minus shot time (msec).

The data point format is "32 bit floating point", and the appropriate bytes (3225-3226) of the binary reel ID header contain a value of 1. The trace amplitudes have not been adjusted for the instrument gain, but the gain correction factor can be estimated from the instrument attenuation value(att) specified in bytes 121- 122. To correct for gain, the data should be demeaned and then multiplied by:

$$\frac{(att/20)}{10}$$

The measurement system (bytes 3225-3226 of the binary reel header) is set to 1, meters.

Shot point and receiver coordinates are in seconds of arc (byte field 89-90). The coordinate scalar multiplier (bytes 71-72) is set to -100, so the coordinates (bytes 73-88) are in hundredths of a second of arc.

Bytes 157-166 and bytes 181-182 refer to the shot detonation time. The time of the first data sample is found by adding the shot detonation time to the time specified in bytes 201-204.

Since there is no weighting of amplitudes with distance for archive tapes, the distance weighting exponent (bytes 191-192) is not used.

Shot sequence number (bytes 193-194) refers to the order in which shots were fired during the field campaign.